

Classic Instruments

Performance Gauge Set

Installation Manual

Table of Contents

Welcome from the Team at Classic Instruments!	3
Speedometer Installation	4
Speedometer Wiring	4
16-Pulse GM / Chrysler Signal Generator [SN16]	5
Ford Signal Generator Adapter [SN17]	5
Speedometer Wiring Diagrams	6
Speedometer Calibration	7
Entering Calibration Mode:	7
Speedometer “Instant” Calibration:	8
Speedometer “Real-Time” Calibration:	9
Speedometer “Measured Mile” Calibration:	10
Reset Gauge Calibration to Factory Defaults:	10
Tachometer Installation	10
Tachometer Wiring	11
Tachometer Setup	13
Set Signal Type	13
Set # of Cylinder Signal Type	13
Optional: Set Shift Light Trigger Point	13
2-5/8” Short Sweep Gauge Installation	14
2 5/8” Short Sweep Gauge Wiring	14
Full Sweep Oil Pressure Gauge Installation	15
Full Sweep Oil Pressure Gauge Wiring	15
Full Sweep Oil Pressure Gauge Setup	16
Full Sweep Temperature Gauge Installation	17
Full Sweep Temperature Gauge Wiring	17
Full Sweep Temperature Gauge Setup	18
Full Sweep Fuel Gauge Installation	19
Full Sweep Fuel Gauge Wiring	19
Full Sweep Fuel Gauge Setup	20
Full Sweep Volt Gauge Installation	22
Full Sweep Volt Gauge Wiring	22
Full Sweep Volt Gauge Setup	23
Oil Pressure Sender Installation	24
Fuel Sender Installation	25
Temperature Sender Installation	26

Welcome from the Team at Classic Instruments!

Our congratulations and appreciation for your purchase of one of the finest quality sets of specialty instruments ever produced! Your instrument set has been conceived, designed, and manufactured by Classic Instruments, Inc. in the U.S.A. Each instrument has been tested and certified for accuracy and quality before packaging and shipping.

For trouble-free installation and operation follow the instructions exactly as outlined. Your instruments were assembled to precise specifications and although each has a seven (7) year warranty covering defective parts and workmanship – this warranty will not cover instruments or sender units which have been installed incorrectly.

Follow our recommended procedures for installation and proper hookup to maintain the value and appearance of your instrument set during many future years of accurate and dependable service!

LIMITED WARRANTY

Classic Instruments, Inc. (CI) warrants to the original purchaser that any CI product manufactured or supplied by CI will be free from defects in material and workmanship under normal use and service for a period of seven (7) years from date of purchase.

Improper installation, use of sending units other than CI's or attempted repair or adjustments by other than CI shall void this warranty. Disassembly of any instruments or senders for whatever reason shall specifically void this warranty.

It's always easy to look to a part for an issue with your set. Before you conclude that a part may be bad, thoroughly check your work. Today's semiconductors and passive components have reached incredibly high reliability levels, but there is still room for error in our human construction skills. However, on rare occasions a sour part can slip through. Please be aware that testing can usually determine if the part was truly defective or damaged by assembly or usage. Don't be afraid of telling us that you "blew it", we're all human and in most cases, replacement parts are very reasonably priced.

Purchaser requesting a product to be repaired or replaced under warranty must first call CI at 1-800-575-0461 before the return of defective part. Send defective part to 826 Moll Drive, Boyne City, MI 49712, USA. Include a written description of the failure with defective part.

Purchaser agrees and accepts that under no circumstances will a warranty replacement be furnished until CI has first received, inspected, and tested the returned part.

All other warranties expressed or implied are hereby excluded including any implied warranty of merchandise and implied warranty of fitness for a particular purpose. The sole and exclusive remedy for breach of this warranty is limited to the replacement set forth above.

It is expressly agreed that there shall be no further remedy for consequential or other type of damage, including any claim for loss of profit, engine damage or injury.

TECHNICAL ASSISTANCE

1-800-575-0461

OR

Visit our website for the latest in gauge design and updates to our installation manual

www.classicinstruments.com

Speedometer Installation

- 1) Make sure you have sufficient clearance (3 ½") behind the panel where you intend to mount the speedometer.
- 2) If necessary, cut a 3.375" hole or 4.625" hole (depending on which speedometer you have) in the dash panel at the desired location.
- 3) Fit the mounting bracket over the mounting studs of the speedometer. The legs of the bracket may be shortened if required.

Speedometer Wiring

- 1) Always disconnect the ground lead from the vehicle battery before wiring any gauge.
- 2) Connect a fused & keyed +12V power source to the **Pink** wire of the gauge harness. *We recommend using a dedicated power source for the speedometer to avoid possible problems caused by interference.*
- 3) Connect a good chassis ground to the **Black** wire of the gauge harness. *We recommend using a dedicated chassis ground (not stacked with other ground wires) to avoid possible problems caused by a bad ground.*
- 4) Connect dash light power to the **Grey** wire of the gauge harness.
- 5) Connect a speed signal to the **Purple** wire of the gauge harness:
 - a. White signal wire from a Classic Instruments pulse signal generator (SN16 or SN16F)
 - i. Connect the Black wire of the pulse signal generator to a good chassis ground.
 - ii. Connect the Red wire of the pulse signal generator to the **Red** wire of the gauge harness.
 - [OR]
 - b. One (either) wire of an electronic transmission's 2-wire vehicle speed sensor [VSS].
 - i. Connect the other VSS wire to the same ground used for the gauge.
 - [OR]
 - c. Speedometer Signal wire of the vehicle computer [PCM].
 - i. Also set the filter switch next to the gauge plug to ON.
- 6) Connect one wire of the speedometer calibration button to the **Brown** wire of the gauge harness.
 - a. Connect the other wire of the calibration button to a good chassis ground.
- 7) Optional: Connect right turn indicator power to the **Purple / White** wire of the gauge harness.
- 8) Optional: Connect high beam indicator power to the **Lt. Green** wire of the gauge harness.
- 9) Optional: Connect left turn indicator power to the **Blue / White** wire of the gauge harness.

16-Pulse GM / Chrysler Signal Generator [SN16]

Attach the signal generator to the transmission speedometer gear housing (where the speedometer cable originally connected). Do not use excessive force to tighten. These signal generators produce approximately 16,000 pulses per mile (PPM).

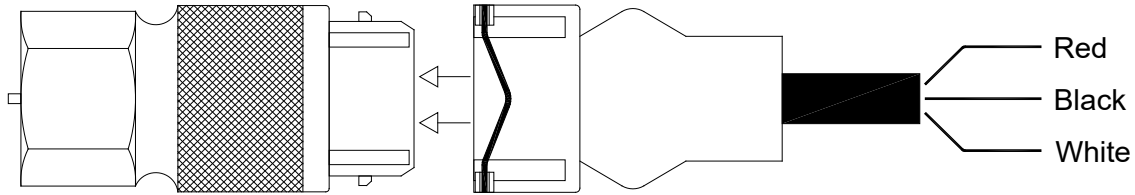

Red: Power (to **Red** wire of the speedometer harness)
Black: Ground (to ground chassis ground)
White: Signal (to **Purple** wire of the speedometer harness)

Ford Signal Generator Adapter [SN17]

The SN17 adapter allows the SN16 signal generator to be used on a Ford or Tremec transmission with a cable speedometer drive.

Slide a speedometer driven gear onto the end of the adapter and retain with a snap ring (not provided with sender). The number of teeth on the gear does not matter since all Classic Instruments speedometers are able to be calibrated electronically. Make sure the gear spins freely on the adapter (*with SN16 already attached*) before installing into the transmission.

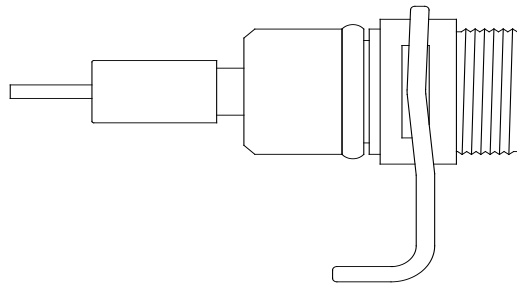

Speedometer Wiring Diagrams

3 3/8" Speedometer Wiring

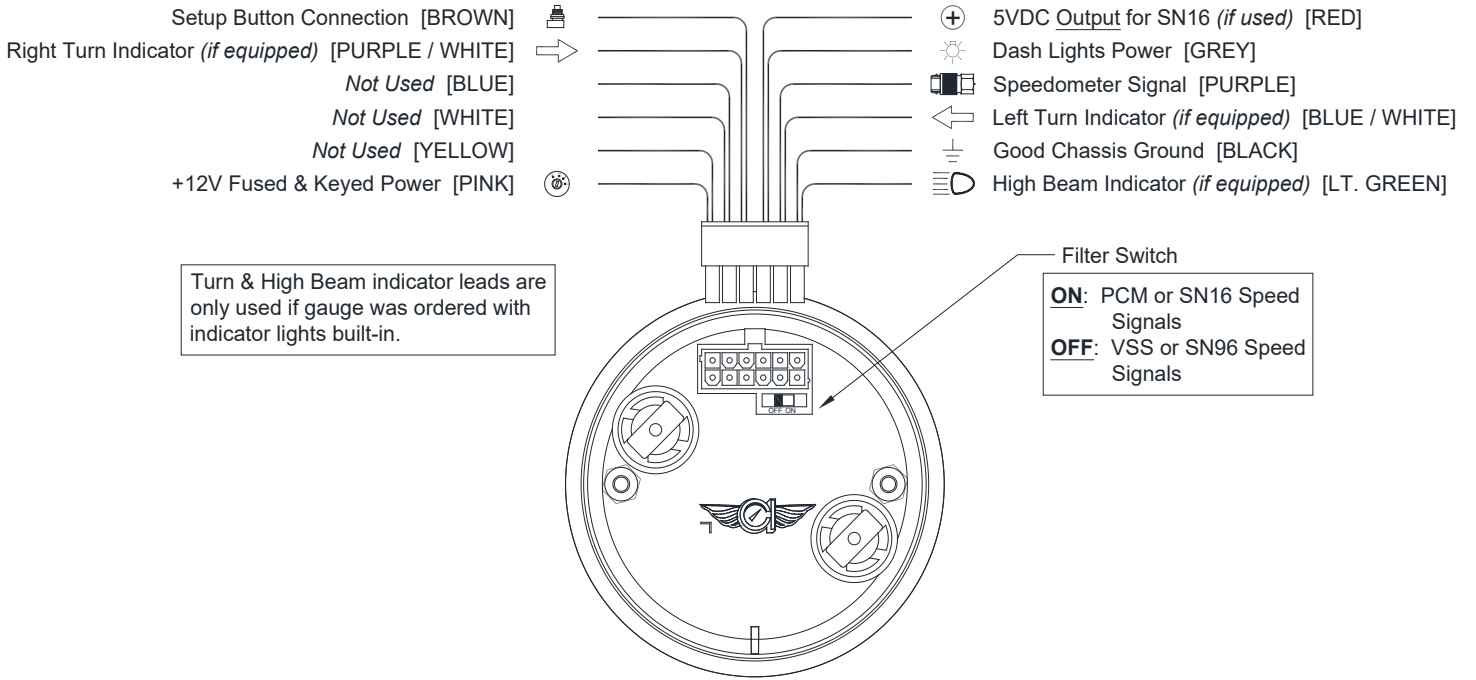

4 5/8" Speedometer Wiring

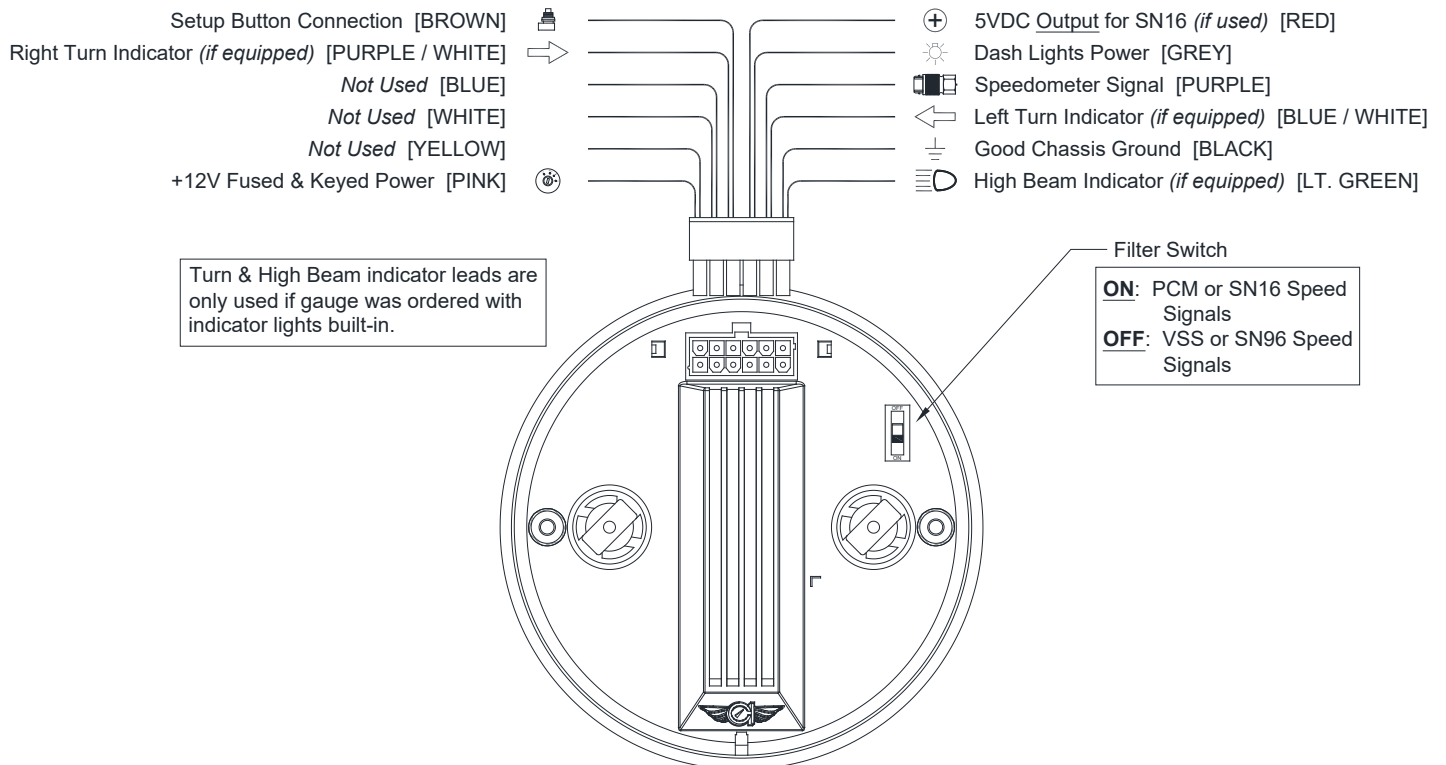

Speedometer Calibration

Note: Before performing speedometer calibration, insure you have a good speed signal. Take a test drive and make sure the speedometer shows a speed (even though it may not be correct)! If the speedometer doesn't show a speed, troubleshoot the speed signal before attempting to calibrate the speedometer.

Only one calibration method is necessary to perform to calibrate the speedometer. Pick the method that works best for you.

- The “Instant” calibration method requires a GPS reference speed signal (or pace car). You will need to drive at 30mph. This method is convenient if the speedometer is more than 10mph off at a known 60mph.
- The “Real-time” calibration method requires a GPS reference speed signal (or pace car). This method allows you to drive at any known speed and make changes to the speedometer reading as you go. This method is best used if the speedometer calibration is less than 10mph off at a known 60mph.
- The “Measured Mile” calibration method requires you to drive a known mile. This is convenient when a GPS is not available to use as a reference and also if the calibration is off more than 10mph at a known 60mph. The speed at which you drive the known mile can be varied, a GPS reference or pace car is not necessary.

Calibration Modes	
Speedometer Indication	Calibration Mode
50 MPH	Speedometer “Instant” Calibration
60 MPH	Speedometer “Real-time” Calibration
70 MPH	Speedometer “Measured Mile” Calibration
80 MPH	Factory Defaults Reset Mode
90 MPH	Exit calibration Mode

Entering Calibration Mode:

- 1) Start with power to the gauge OFF.
 - 2) Press and HOLD the calibration pushbutton.
 - 3) Start engine.
 - 4) Release the pushbutton after the engine is started. The speedometer will indicate 50MPH.
-

Speedometer “Instant” Calibration:

(steps 1-4 may be skipped if the gauge is already in calibration mode)

- 1) Start with power to the gauge OFF.
- 2) Press and HOLD the calibration pushbutton.
- 3) Start engine.
- 4) Release the pushbutton after the engine is started. The speedometer will indicate 50MPH.
- 5) With the speedometer indicating 50MPH, press and hold the calibration pushbutton until the speedometer changes to 0 MPH. *If the speedometer pointer is not at 50MPH, tap the button to cycle the pointer through the calibration modes until it comes back to 50MPH.*
- 6) Drive the vehicle at exactly 30MPH using a GPS or pace car as a reference. Press and hold the pushbutton while traveling 30MPH for approximately 4 seconds until the speedometer moves up to 30MPH. The speedometer will now track your speed. Verify that the speedometer is now reading accurately.
- 7) If you are satisfied with the speedometer calibration, tap the pushbutton to get back to the calibration mode options. If you would like to re-do the calibration, press and hold the pushbutton to restart the Instant Calibration process.
- 8) When you are finished, tap the pushbutton (as many times as needed) to move the speedometer pointer through the calibration modes to get to the 90MPH (Exit Calibration Mode) option. With the pointer at 90MPH, press and hold the button for about 6 seconds until the speedometer moves down and starts indicating your actual speed. The speedometer calibration is now saved.

Speedometer “Real-Time” Calibration:

(steps 1-4 may be skipped if the gauge is already in calibration mode)

- 1) Start with power to the gauge OFF.
- 2) Press and HOLD the calibration pushbutton.
- 3) Start engine.
- 4) Release the pushbutton after the engine is started. The speedometer will indicate 50MPH.
- 5) Tap the calibration pushbutton once to move the speedometer pointer up to 60MPH. *If you missed stopping the pointer at 60MPH, continue to tap the button to cycle the pointer through the calibration modes until it comes back to 60MPH.*
- 6) With the speedometer indicating 60MPH, press and hold the calibration pushbutton until the speedometer changes to 0 MPH.
- 7) Begin driving a known speed using a GPS or pace vehicle as a reference.
- 8) Press and hold the pushbutton to slowly change the indicated speed. The first time the button is pressed will increase the speedometer reading. The next time the button is pressed will decrease the speedometer reading. The speedometer will alternate between increasing and decreasing speed each time the button is pressed and held.
- 9) Continue to press and hold the pushbutton until the speedometer is indicating the correct speed.
- 10) Once the correct speed is dialed in on the speedometer, wait 8 seconds without pressing the pushbutton to have the current calibration saved. *If you still need to adjust the speed after this 8 second timeout, press and hold the button to re-enter the “Real Time” calibration mode again.*
- 11) If you are satisfied with the speedometer calibration, tap the pushbutton (as many times as needed) to move the speedometer pointer through the calibration modes to get to the 90MPH (Exit Calibration Mode) option. With the pointer at 90MPH, press and hold the button for about 6 seconds until the speedometer moves down and starts indicating your actual speed. The speedometer calibration is now saved.

Speedometer “Measured Mile” Calibration:

(steps 1-4 may be skipped if the gauge is already in calibration mode)

- 1) Start with power to the gauge OFF.
- 2) Press and HOLD the calibration pushbutton.
- 3) Start engine.
- 4) Release the pushbutton after the engine is started. The speedometer will indicate 50MPH.
- 5) Tap the calibration pushbutton twice to move the speedometer pointer up to 70MPH. *If you missed stopping the pointer at 70MPH, continue to tap the button to cycle the pointer through the calibration modes until it comes back to 70MPH.*
- 6) With the speedometer indicating 70MPH, press and hold the calibration pushbutton until the speedometer changes to 30 MPH.
- 7) Begin driving a known measured mile. *The speed at which you drive the mile does not matter.*
- 8) At the end of the mile, press and hold the pushbutton until the speedometer moves from 30MPH back up to 70MPH. *To get a more accurate calibration, stop at the end of the mile.*
- 9) If you are satisfied with the speedometer calibration, tap the pushbutton (as many times as needed) to move the speedometer pointer through the calibration modes to get to the 90MPH (Exit Calibration Mode) option. With the pointer at 90MPH, press and hold the button for about 6 seconds until the speedometer moves down and starts indicating your actual speed. The speedometer calibration is now saved.

Reset Gauge Calibration to Factory Defaults:

(steps 1-4 may be skipped if the gauge is already in calibration mode)

- 1) Start with power to the gauge OFF.
- 2) Press and HOLD the calibration pushbutton.
- 3) Start engine *(or just turn the key ON)*.
- 4) Release the pushbutton after the engine is started *(or the key has been turned ON)*. The speedometer will indicate 50MPH.
- 5) Tap the calibration pushbutton three times to move the speedometer pointer up to 80MPH. *If you missed stopping the pointer at 80MPH, continue to tap the button to cycle the pointer through the calibration modes until it comes back to 80MPH.*
- 6) With the speedometer indicating 80MPH, press and hold the calibration pushbutton until the speedometer changes to 90 MPH. The factory speedometer calibration is now set.
- 7) With the speedometer pointer at 90MPH, press and hold the button for about 6 seconds until the speedometer pointer moves down to zero.

Tachometer Installation

- 1) Make sure you have sufficient clearance (3 ½”) behind the panel where you intend to mount the tachometer.
- 2) If necessary, cut a 3.375” diameter hole or 4.625” diameter hole (depending on which size tachometer you have) in the dash panel at the desired location.
- 3) Fit the mounting bracket over the mounting studs of the tachometer. The legs of the bracket may be shortened if required.

Tachometer Wiring

- 1) Always disconnect the ground lead from the vehicle battery before wiring any gauge.
- 2) Connect a fused & keyed +12V power source to the **Pink** wire of the gauge harness.
- 3) Connect a good chassis ground to the **Black** wire of the gauge harness.
- 4) Connect dash light power to the **Grey** wire of the gauge harness.
- 5) Connect one wire of the tachometer calibration button to the **Brown** wire of the gauge harness.
 - a. Connect the other wire of the calibration button to a good chassis ground.
- 6) Optional: Connect a remote shift light indicator's Ground to the **Yellow / White** wire of the gauge harness.
 - a. *Connect the shift light indicator's Power to switched +12VDC.*
- 7) Connect a tachometer signal to the **White** wire of the gauge harness. Refer to the following list of ignition system types to help determine where to get the signal.

STANDARD POINTS & CONDENSER SYSTEM

Connect the negative side of the coil (usually marked as “-”) to the white wire of the gauge harness.

GMC – HEI (High Energy Ignition System)

Connect the “TACH” terminal on coil side of distributor cap to the white wire of the gauge harness.

MSD (Multiple Spark Discharge System)

Connect the Tach signal on the MSD box to the white wire of the gauge harness.

VERTEX MAGNETO SYSTEM

Connect the “KILL” terminal on the side of a Vertex magneto body to the white wire of the gauge harness. An external adapter such as an MSD “Pro Mag Tach Converter” #8132 may be required.

ACCEL IGNITION COILS

Connect the negative side of the coil to the white wire of the gauge harness. CAUTION! Some Accel ignition coils require the tach signal wire to be connected to the “+” terminal on the coil! PLEASE carefully read Accel's instructions before connecting ignition coil.

MALLORY IGNITION

Connect the negative terminal side of coil (usually marked as “-”) to the white wire of the gauge harness.

IMPORTANT! Some Mallory ignition systems may require you to adjust the tachometer at the 4-cylinder setting (rather than the 8-cylinder setting).

ECM TACHOMETER SIGNAL

Connect the signal wire from the ECM to the white wire of the gauge harness. When using this type of signal, you may need to set the tachometer to the 4-cylinder setting regardless of the actual cylinders on the engine. Also, set the signal type to 5V when using this signal.

MULTIPLE COIL IGNITION SYSTEMS

A tach adapter is required for these ignition systems. A tach signal driver such as the MSD #8913, which produces a 12V square wave signal, is recommended along with a SN74Z signal converter. Please check with manufacturer for your specific application.

NOTICE! For all other ignition systems please look at the owner's manual for that system.

4 5/8-Inch Tachometer

- Setup Button Connection [BROWN] 
- Good Chassis Ground [BLACK] 
- Tachometer Signal [WHITE] 
- Shift Light Output [YELLOW / WHITE] 
-  Dash Light Power [GREY]
-  +12V Fused & Keyed Power [PINK]

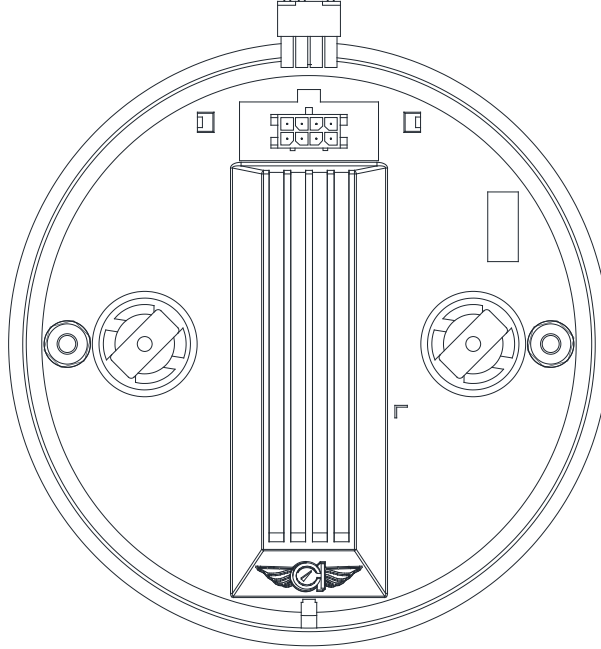

3 3/8-Inch Tachometer

- Setup Button Connection [BROWN] 
- Good Chassis Ground [BLACK] 
- Tachometer Signal [WHITE] 
- Shift Light Output [YELLOW / WHITE] 
-  Dash Light Power [GREY]
-  +12V Fused & Keyed Power [PINK]

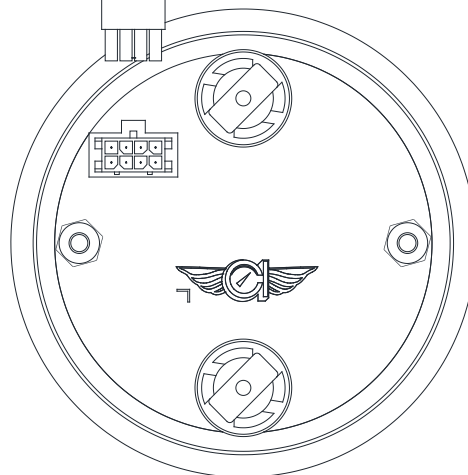

Tachometer Setup

Set Signal Type:

1. Start with power off.
2. Press and hold pushbutton.
3. While pressing pushbutton, apply power to the gauge (starting vehicle not necessary).
4. Release pushbutton once power is applied.
5. Tachometer pointer will indicate 2000 RPM.
6. Press and hold the pushbutton (with tachometer reading 2000 RPM) until the pointer moves to indicate the signal type.
7. Tapping the pushbutton will cause the pointer to alternate between 5000 RPM “Low Voltage Signal” (from an ECM) and 6000 RPM “High Voltage Signal” (from standard, HEI or CDI {MSD} ignitions).
8. Press and hold the pushbutton until the pointer returns to 0 RPM to save the setting.

Set # of Cylinder Signal Type:

1. Start with power off.
2. Press and hold pushbutton.
3. While pressing pushbutton, apply power to the gauge (starting vehicle not necessary).
4. Release pushbutton once power is applied.
5. Tachometer pointer will indicate 2000 RPM.
6. Tap the pushbutton to index the pointer to 4000 RPM “4-cylinder”, 6000 RPM “6-cylinder” or 8000 RPM “8-cylinder”.
7. Press and hold the pushbutton with the pointer indicating the desired setting (4000, 6000 or 8000) to set the signal type. Once set, the pointer will return to 0 RPM.

Optional: Set Shift Light Trigger Point:

1. Start with power off.
2. Press and hold pushbutton.
3. While pressing pushbutton, apply power to the gauge (starting vehicle not necessary).
4. Release pushbutton once power is applied.
5. Tachometer pointer will indicate 2000 RPM.
6. Tap the pushbutton to index the pointer to 3000 RPM.
7. Press and hold the pushbutton (with tachometer reading 3000 RPM) until the pointer moves to indicate the shift light trigger point.
8. Press and hold the pushbutton to change the RPM shown. The first time the pushbutton is pressed and held, the RPM shown will increase. The second time the pushbutton is pressed and held, the RPM shown will decrease. The RPM shown will alternate between increasing and decreasing each time the pushbutton is pressed.
9. Once the correct RPM shift light trigger point is shown, wait 8 seconds without pushing the pushbutton in order to save the setting. The pointer will return to 0 RPM.

Important: Turn power OFF to save changes

2-5/8" Short Sweep Gauge Installation

- 1) Make sure you have sufficient clearance (3") behind the panel where you intend to mount the gauge.
- 2) If necessary, cut a 2.625" hole in the dash panel at the desired location.
- 3) Fit the mounting bracket over the mounting studs located on the back of the gauge. The legs of the bracket may be shortened if required.

2 5/8" Short Sweep Gauge Wiring

- 1) Always disconnect the ground lead from the vehicle battery before wiring any gauge.
- 2) Connect the sender to the **White** wire of the gauge harness.
 - a. Volt gauge: No sender is required. **DO NOT connect anything to the White signal wire! Doing so will damage the gauge!**
 - b. Water Temperature gauge: Connect the top terminal of a Classic Instruments temperature sender to the White wire of the gauge harness.
 - c. Oil Pressure gauge: Connect the top terminal of a Classic Instruments oil pressure sender to the White wire of the gauge harness.
 - d. Fuel gauge: Connect the top terminal of a Classic Instruments fuel sender (or signal terminal of an OEM fuel sender if matching gauge was ordered) to the White wire of the gauge harness.
 - e. Transmission Temperature gauge: Connect the top terminal of a Classic Instruments transmission temperature sender to the White wire of the gauge harness.
 - f. Oil Temperature gauge: Connect the top terminal of a Classic Instruments oil temperature sender to the White wire of the gauge harness.
- 3) Connect a good ground to the **Black** wire of the gauge harness.
- 4) Connect a fused & keyed +12V power source to the **Pink** wire of the gauge harness.
- 5) Connect dash light power to the **Grey** wire of the gauge harness.

2 5/8" Short Sweep Gauge Wiring

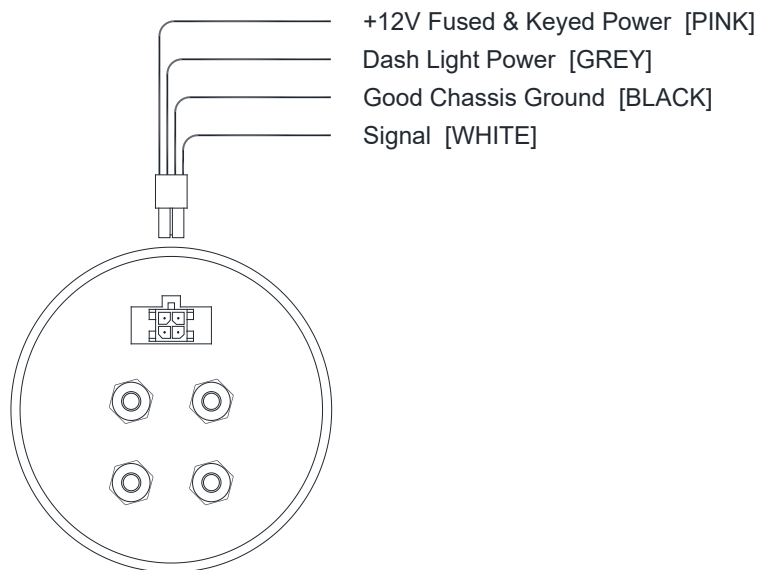

Full Sweep Oil Pressure Gauge Installation

- 1) Make sure you have sufficient clearance (2 3/4") behind the panel where you intend to mount the gauge.
- 2) If necessary, cut a 2-1/8" or 2-5/8" diameter hole in the dash panel at the desired location.
- 3) Fit the mounting bracket over the mounting studs of the gauge. The legs of the bracket may be shortened if required.

Full Sweep Oil Pressure Gauge Wiring

- 1) Connect a fused & keyed +12V power source to the **PINK** wire of the gauge harness.
- 2) Connect dash light power to the **GREY** wire of the gauge harness.
- 3) Connect a good chassis ground to the **BLACK** wire of the gauge harness.
- 4) Connect one wire of the setup pushbutton to the **BROWN** wire of the gauge harness.
 - a. Connect the other wire of the setup button to ground.
- 5) Connect the red wire of the sensor to the **RED / WHITE** wire of the gauge harness.
 - a. Connect the black wire of the sensor to ground.
- 6) Connect the blue wire of the sensor to the **WHITE** wire of the gauge harness.
- 7) *Optional:* Connect an optional warning LED light's ground wire to the **YELLOW / WHITE** wire of the gauge harness.
 - a. The warning LED light should have switched power going to its power wire.
- 8) *Optional:* Connect a data logger input signal to the **ORANGE / WHITE** wire of the gauge harness. This wire has 0.5V at 0 PSI and 4.5V at 100 PSI.

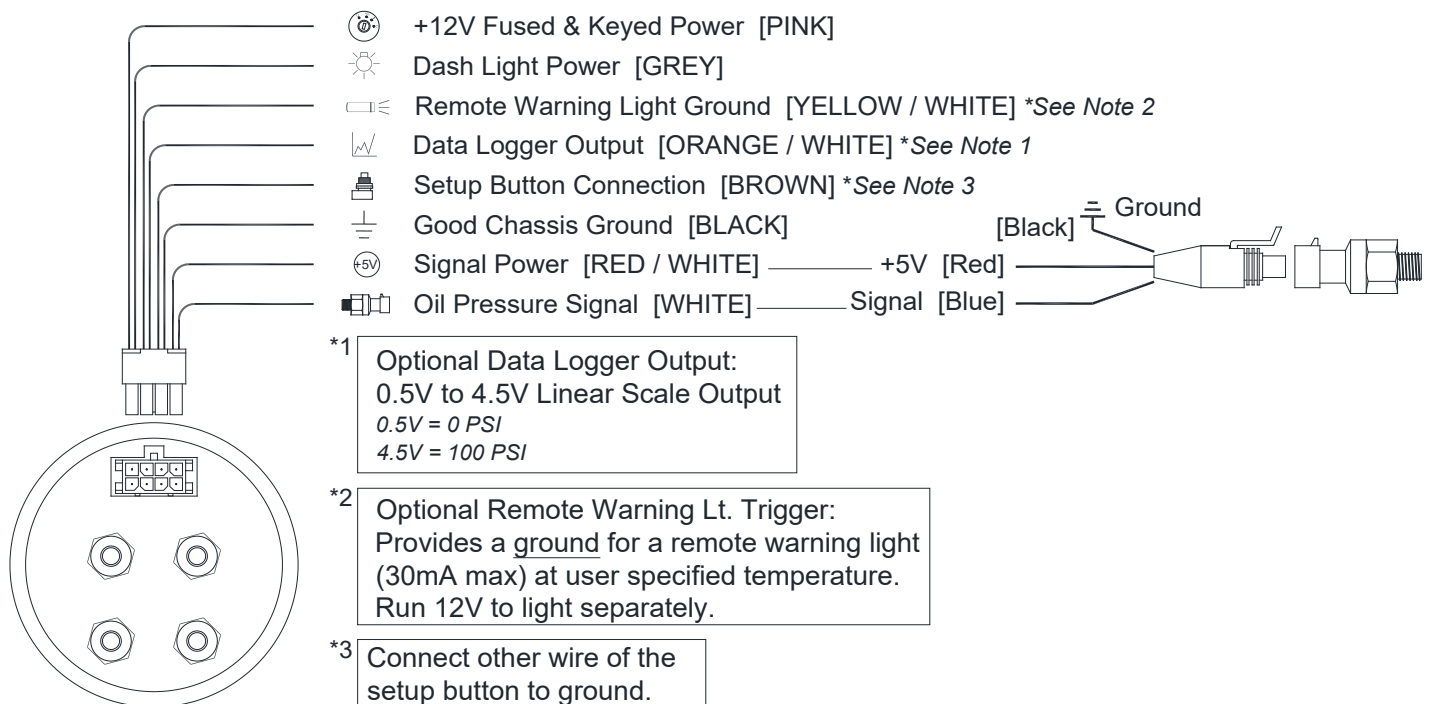

Full Sweep Oil Pressure Gauge Setup

To Set Backlight Color (cool white / warm white):

1. Start with power off.
2. Press and hold pushbutton.
3. While pressing pushbutton, apply power to the gauge (starting vehicle not necessary).
4. Release pushbutton once power is applied.
5. The pointer will indicate 50 PSI.
6. Tap the pushbutton to move the pointer to 0 PSI.
7. With the pointer indicating 0 PSI, press and hold the pushbutton until the pointer moves to 25 PSI or 75 PSI.
8. 25 PSI represents the “cool white” lighting option and 75 PSI represents the “warm white” lighting option. Tap the pushbutton to move the pointer between 25 PSI and 75 PSI.
9. When the pointer is indicating the desired lighting option; press and hold the pushbutton until the pointer returns to 0 PSI. Turn off power to save the changes.

To Set Warning Light Trigger Point:

10. Start with power off.
11. Press and hold pushbutton.
12. While pressing pushbutton, apply power to the gauge (starting vehicle not necessary).
13. Release pushbutton once power is applied.
14. The pointer will indicate 50 PSI.
15. Tap the pushbutton twice to move the pointer to 0 PSI and back to 50 PSI again.
16. Press and hold the pushbutton (with the pointer at 50 PSI) until the pointer moves to indicate the warning light trigger point.
17. Press and hold the pushbutton to change the trigger pressure shown. The first time the pushbutton is pressed and held, the pressure shown will increase. The second time the pushbutton is pressed and held, the pressure shown will decrease. The pressure shown will alternate between increasing and decreasing each time the pushbutton is pressed.
18. If the set trigger pressure is set below 50 PSI, the warning light will come on when the pressure is below the trigger pressure. If the set trigger pressure is set above 50 PSI, the warning light will come on when the pressure is above the trigger pressure.
19. Once the desired trigger point is shown, wait 10 seconds without pushing the pushbutton in order to save the setting. The pointer will return to 0 PSI. Turn off power to save the changes.

Important: Turn power OFF to the gauge after making changes in order to save those changes

Full Sweep Temperature Gauge Installation

- 1) Make sure you have sufficient clearance (2 3/4") behind the panel where you intend to mount the gauge.
- 2) If necessary, cut a 2-1/8" or 2-5/8" diameter hole in the dash panel at the desired location.
- 3) Fit the mounting bracket over the mounting studs of the gauge. The legs of the bracket may be shortened if required.

Full Sweep Temperature Gauge Wiring

- 1) Connect a fused & keyed +12V power source to the **PINK** wire of the gauge harness.
- 2) Connect dash light power to the **GREY** wire of the gauge harness.
- 3) Connect a good chassis ground to the **BLACK** wire of the gauge harness.
- 4) Connect one wire of the setup pushbutton to the **BROWN** wire of the gauge harness.
 - a. Connect the other wire of the setup button to ground.
- 5) Connect the temperature sender signal post to the **WHITE** wire of the gauge harness.
- 6) *Optional:* Connect an optional warning LED light's ground wire to the **YELLOW / WHITE** wire of the gauge harness.
 - a. The warning LED light should have switched power going to its power wire.
- 7) *Optional:* Connect a data logger input signal to the **ORANGE / WHITE** wire of the gauge harness. This wire has 0.5V at 140 °F and 4.5V at 280 °F.
- 8) The **RED / WHITE** wire of the gauge harness IS NOT USED. DO NOT CONNECT!

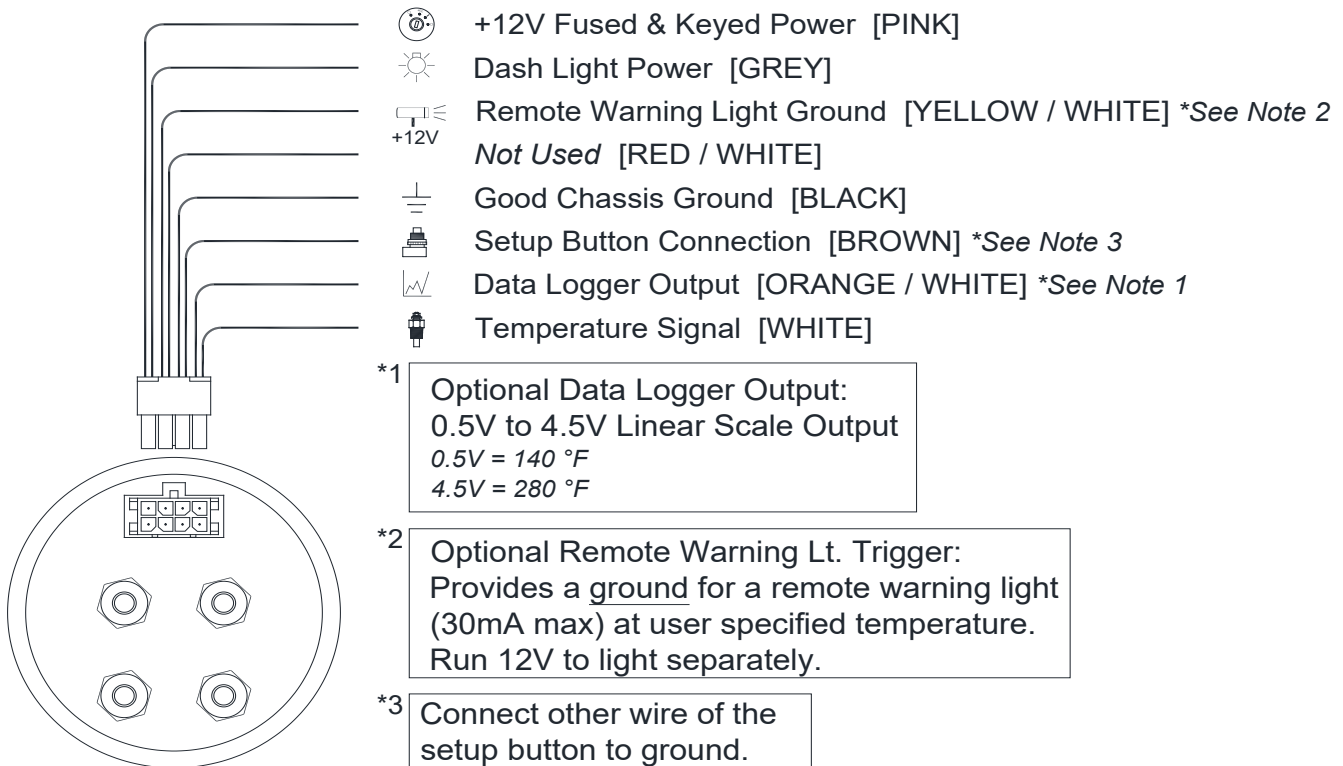

Full Sweep Temperature Gauge Setup

To Set Backlight Color (cool white / warm white):

1. Start with power off.
2. Press and hold pushbutton.
3. While pressing pushbutton, apply power to the gauge (starting vehicle not necessary).
4. Release pushbutton once power is applied.
5. The pointer will indicate 210°F.
6. Tap the pushbutton to move the pointer to 140°F.
7. With the pointer indicating 140°F, press and hold the pushbutton until the pointer moves to 175°F or 245°F.
8. 175°F represents the “cool white” lighting option and 245°F represents the “warm white” lighting option. Tap the pushbutton to move the pointer between 175°F and 245°F.
9. When the pointer is indicating the desired lighting option, press and hold the pushbutton until the pointer returns to 140°F. Turn off power to save the changes.

To Set Warning Light Trigger Point:

1. Start with power off.
2. Press and hold pushbutton.
3. While pressing pushbutton, apply power to the gauge (starting vehicle not necessary).
4. Release pushbutton once power is applied.
5. The pointer will indicate 210°F.
6. Tap the pushbutton twice to move the pointer to 140°F and back to 210°F again.
7. Press and hold the pushbutton (with the pointer at 210°F) until the pointer moves to indicate the warning light trigger point.
8. Press and hold the pushbutton to change the trigger temperature shown. The first time the pushbutton is pressed and held, the temperature shown will increase. The second time the pushbutton is pressed and held, the temperature shown will decrease. The temperature shown will alternate between increasing and decreasing each time the pushbutton is pressed.
9. If the set trigger temperature is below 210°F, the warning light will come on when the temperature is below the trigger temperature. If the set trigger temperature is above 210°F, the warning light will come on when the temperature is above the trigger temperature.
10. Once the desired trigger point is shown, wait 10 seconds without pushing the pushbutton in order to save the setting. The pointer will return to 140°F. Turn off power to save the changes.

Important: Turn power OFF to the gauge after making changes in order to save those changes

Full Sweep Fuel Gauge Installation

- 1) Make sure you have sufficient clearance (2 3/4") behind the panel where you intend to mount the gauge.
- 2) If necessary, cut a 2-1/8" or 2-5/8" diameter hole in the dash panel at the desired location.
- 3) Fit the mounting bracket over the mounting studs of the gauge. The legs of the bracket may be shortened if required.

Full Sweep Fuel Gauge Wiring

- 1) Connect a fused & keyed +12V power source to the **PINK** wire of the gauge harness.
- 2) Connect dash light power to the **GREY** wire of the gauge harness.
- 3) Connect a good chassis ground to the **BLACK** wire of the gauge harness.
- 4) Connect one wire of the setup pushbutton to the **BROWN** wire of the gauge harness.
 - a. Connect the other wire of the setup button to ground.
- 5) Connect the fuel sender signal post to the **WHITE** wire of the gauge harness.
- 6) *Optional:* Connect an optional warning LED light's ground wire to the **YELLOW / WHITE** wire of the gauge harness.
 - a. The warning LED light should have switched power going to its power wire.
- 7) *Optional:* Connect a data logger input signal to the **ORANGE / WHITE** wire of the gauge harness. This wire has 0.5V at Empty and 4.5V at Full.
- 8) The **RED / WHITE** wire of the gauge harness IS NOT USED. DO NOT CONNECT!

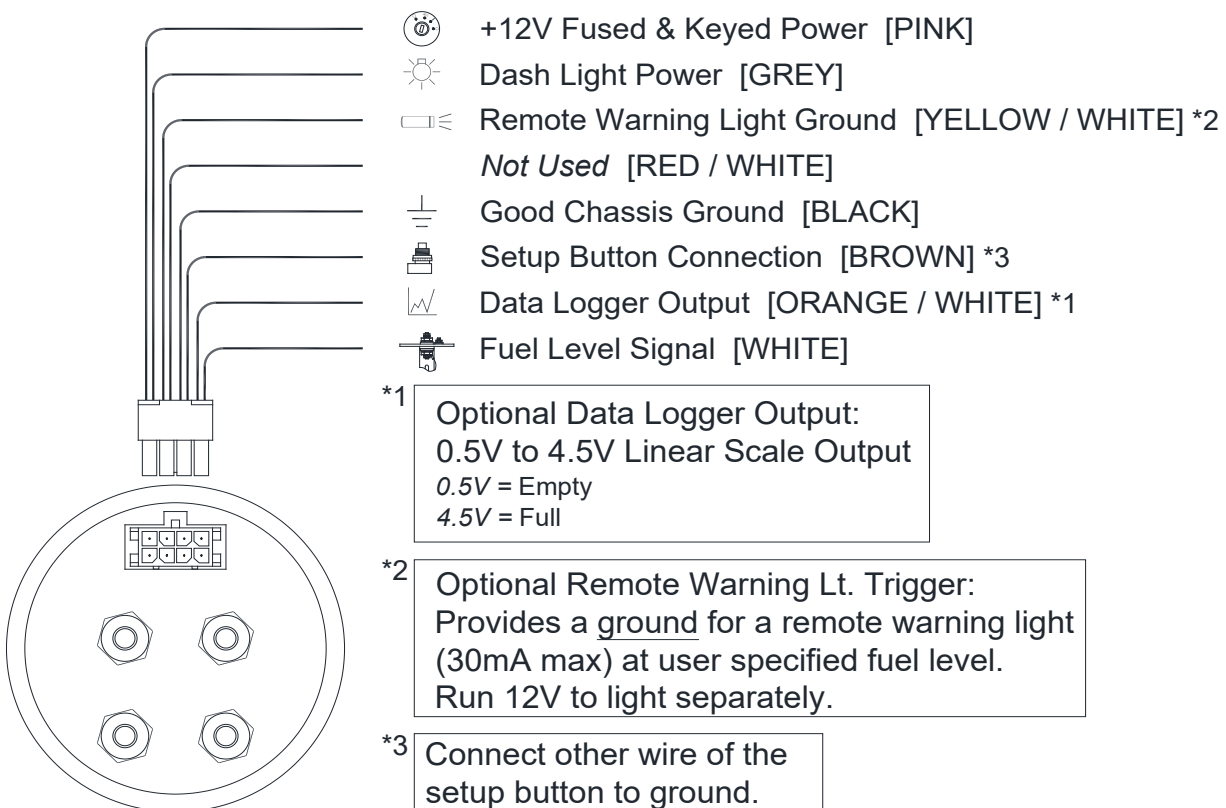

Full Sweep Fuel Gauge Setup

To Set Fuel Sender compatibility

1. Start with power off.
2. Press and hold the pushbutton.
3. While pressing the pushbutton, apply power to the gauge (starting vehicle not necessary).
4. Release pushbutton once power is applied.
5. The pointer will indicate 1/2.
6. Tap the pushbutton three times to move the pointer to Empty, 1/2 and then to Full.
7. Press and hold the pushbutton (with pointer at Full) until the pointer moves back to 1/2. Then, tap the pushbutton once more to move the pointer down to 1/8.
8. Tap the pushbutton to select the fuel compatibility option from the chart below. Tapping the pushbutton will index the pointer to 1/8, 1/4, 3/8, 1/2, 5/8, 3/4 and 7/8 representing the compatibility options.
9. When the pointer is at the desired option, press and hold the pushbutton until the pointer returns to Empty. Turn off power to save the changes.

Gauge Reading	Fuel Sender Compatibility
1/8	240-33Ω (Standard Aftermarket Range)
1/4	0-30Ω (GM Type 1964 and earlier)
3/8	0-90Ω (GM Type 1965 to 1998)
1/2	75-10Ω (Ford Type 1986 and earlier)
5/8	10-180Ω (VDO)
3/4	40-250Ω (GM Type 1998 and later)
7/8	16-158Ω (Ford Type 1987 and later)

To Set Backlight Color (cool white / warm white):

1. Start with power off.
2. Press and hold pushbutton.
3. While pressing pushbutton, apply power to the gauge (starting vehicle not necessary).
4. Release pushbutton once power is applied.
5. The pointer will indicate 1/2.
6. Tap the pushbutton to move the pointer to Empty.
7. With the pointer indicating Empty, press and hold the pushbutton until the pointer moves to 1/4 or 3/4.
8. 1/4 represents the “cool white” lighting option and 3/4 represents the “warm white” lighting option. Tap the pushbutton to move the pointer between 1/4 and 3/4 options.
9. When the pointer is indicating the desired lighting option, press and hold the pushbutton until the pointer returns to Empty. Turn off power to save the changes.

To Set Warning Light Trigger Point:

1. Start with power off.
2. Press and hold pushbutton.
3. While pressing pushbutton, apply power to the gauge (starting vehicle not necessary).
4. Release pushbutton once power is applied.
5. The pointer will indicate 1/2.
6. Tap the pushbutton twice to move the pointer to Empty and back to 1/2 again.
7. Press and hold the pushbutton (with the pointer at 1/2) until the pointer moves to indicate the warning light trigger point.
8. Press and hold the pushbutton to change the trigger level shown. The first time the pushbutton is pressed and held, the level shown will increase. The second time the pushbutton is pressed and held, the level shown will decrease. The level shown will alternate between increasing and decreasing each time the pushbutton is pressed.
9. If the set trigger temperature is below 1/2, the warning light will come on when the level is below the trigger level. If the set trigger level is above 1/2, the warning light will come on when the level is above the trigger level.
10. Once the desired trigger point is shown, wait 10 seconds without pushing the pushbutton in order to save the setting. The pointer will return to Empty. Turn off power to save the changes.

Important: Turn power OFF to the gauge after making changes in order to save those changes

Full Sweep Volt Gauge Installation

- 1) Make sure you have sufficient clearance (2 3/4") behind the panel where you intend to mount the gauge.
- 2) If necessary, cut a 2-1/8" or 2-5/8" diameter hole in the dash panel at the desired location.
- 3) Fit the mounting bracket over the mounting studs of the gauge. The legs of the bracket may be shortened if required.

Full Sweep Volt Gauge Wiring

- 1) Connect a fused & keyed +12V power source to the **PINK** wire of the gauge harness.
- 2) Connect dash light power to the **GREY** wire of the gauge harness.
- 3) Connect a good chassis ground to the **BLACK** wire of the gauge harness.
- 4) Connect one wire of the setup pushbutton to the **BROWN** wire of the gauge harness.
 - a. Connect the other wire of the setup button to ground.
- 5) *Optional:* Connect an optional warning LED light's ground wire to the **YELLOW / WHITE** wire of the gauge harness.
 - a. The warning LED light should have switched power going to its power wire.
- 6) *Optional:* Connect a data logger input signal to the **ORANGE / WHITE** wire of the gauge harness. This wire has 0.5V at Empty and 4.5V at Full.
- 7) The **RED / WHITE** and **WHITE** wires of the gauge harness IS NOT USED. DO NOT CONNECT!

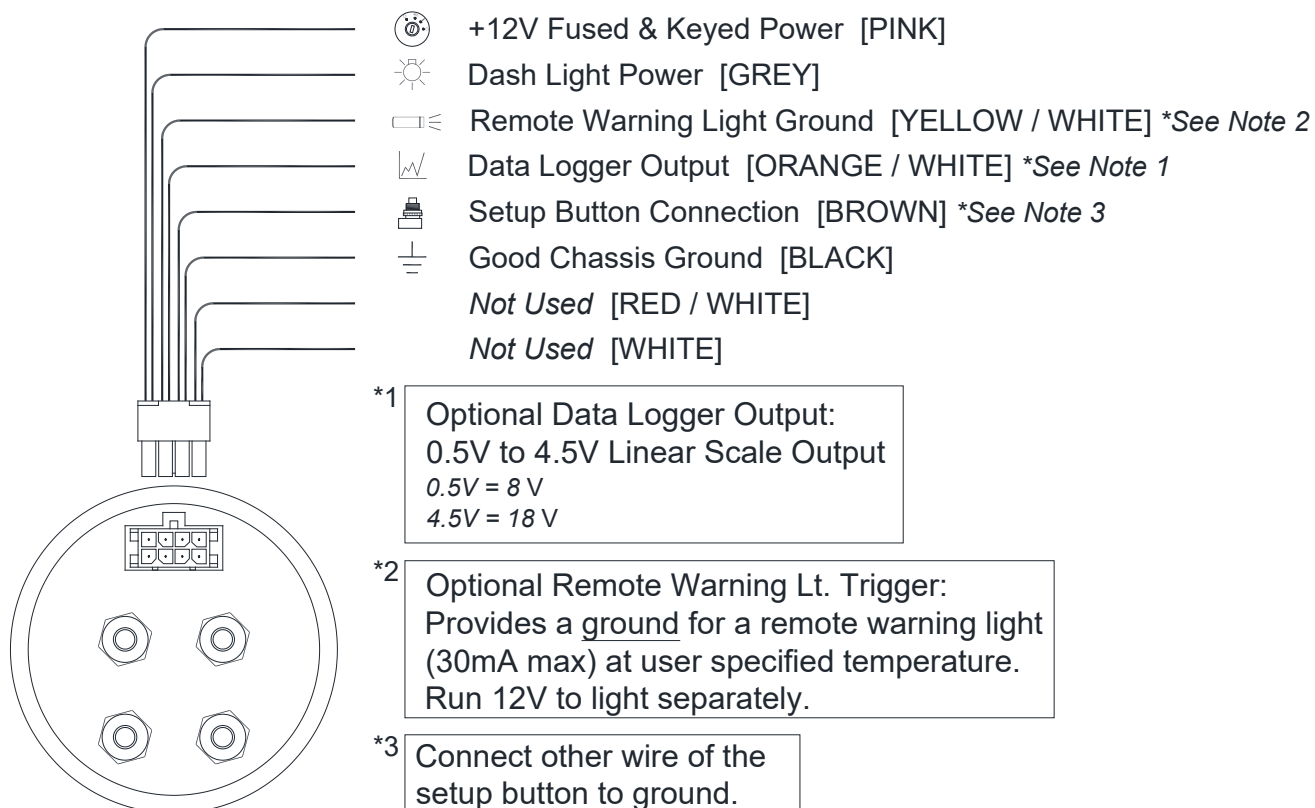

Full Sweep Volt Gauge Setup

To Set Backlight Color (cool white / warm white):

1. Start with power off.
2. Press and hold pushbutton.
3. While pressing pushbutton, apply power to the gauge (starting vehicle not necessary).
4. Release pushbutton once power is applied.
5. The pointer will indicate 13 V.
6. Tap the pushbutton to move the pointer to 8 V.
7. With the pointer indicating 8 V, press and hold the pushbutton until the pointer moves to 10.5 V or 15.5 V.
8. 10.5 V represents the “cool white” lighting option and 15.5 V represents the “warm white” lighting option. Tap the pushbutton to move the pointer between 10.5 V and 15.5 V.
9. When the pointer is indicating the desired lighting option, press and hold the pushbutton until the pointer returns to 8 V. Turn off power to save the changes.

To Set Warning Light Trigger Point:

1. Start with power off.
2. Press and hold pushbutton.
3. While pressing pushbutton, apply power to the gauge (starting vehicle not necessary).
4. Release pushbutton once power is applied.
5. The pointer will indicate 13 V.
6. Tap the pushbutton twice to move the pointer to 8 V and back to 13 V again.
7. Press and hold the pushbutton (with the pointer at 13 V) until the pointer moves to indicate the warning light trigger point.
8. Press and hold the pushbutton to change the trigger voltage shown. The first time the pushbutton is pressed and held, the voltage shown will increase. The second time the pushbutton is pressed and held, the voltage shown will decrease. The voltage shown will alternate between increasing and decreasing each time the pushbutton is pressed.
9. If the set trigger voltage is set below 13V, the warning light will come on when the voltage is below the trigger voltage. If the set trigger voltage is set above 13 V, the warning light will come on when the voltage is above the trigger voltage.
10. Once the desired trigger point is shown, wait 10 seconds without pushing the pushbutton in order to save the setting. The pointer will return to 0 PSI. Turn off power to save the changes.

Important: Turn power OFF to the gauge after making changes in order to save those changes

Oil Pressure Sender Installation

Part No. SN52 (short sweep)

Part No. SN64 (full sweep)

- 1) Disconnect battery before installation.
- 2) Only install Classic Instruments sending units when the engine is COLD.
- 3) DO NOT use Teflon tape on the SN52 threads. These threads are slightly tapered and designed to be self-sealing. The sender uses the threads for its ground connection and sealant may cause a poor ground causing inaccurate readings.
- 4) Teflon tape may be used on the SN64 threads if needed.

GM Installation: The correct location on most GM V8-engines to install the oil pressure sender is under the distributor housing at the rear of the block.

Use the 2 piece bushing kit provided to allow the sender to be mounted at a 45-degree angle pointing towards the driver's knees. This allows the sender to clear the back of the intake manifold, the underside of the distributor housing and also the firewall.

GM Installation – Big Block Engines: We do NOT recommend installing Classic Instrument's oil pressure sender in the opening located just above the oil filter on some big block GM engines.

This location may not be a full-pressure passage but instead a "by-pass" oil passageway. Installing our pressure sender at this location may result in some strange low-pressure readings under certain driving conditions. This does not indicate a defective instrument or sender! It simply means you need to move the sender to the correct location.

GM Installation – LS Engines: Install the sender in the oil bypass housing located just above the oil filter. The housing will need to be drilled and tapped to 1/8"NPT.

FORD Installation: Install the Classic Instrument's oil pressure sender in the Ford V-8 block using the brass bushing kit (all three pieces) provided. These bushings allow the pressure sender to be installed between the motor mount and stock fuel pump. Ford also manufactures a pressure sender extension and if your engine has one of these in place, our brass bushing kit will not be required.

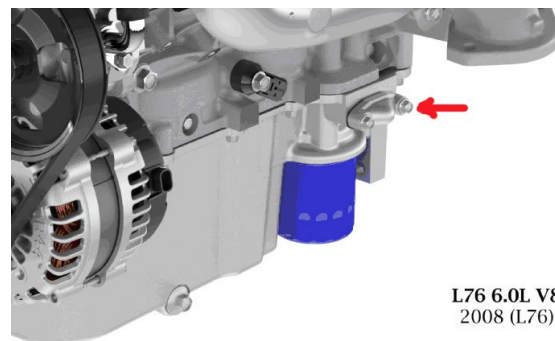
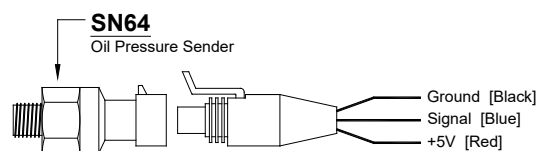
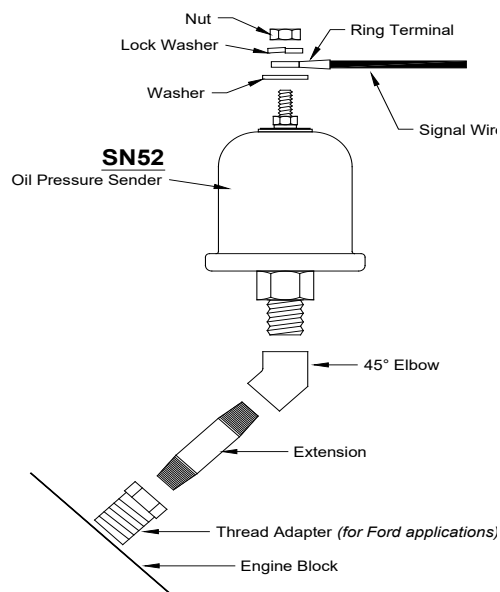

LS1 Oil Bypass Housing

Fuel Sender Installation

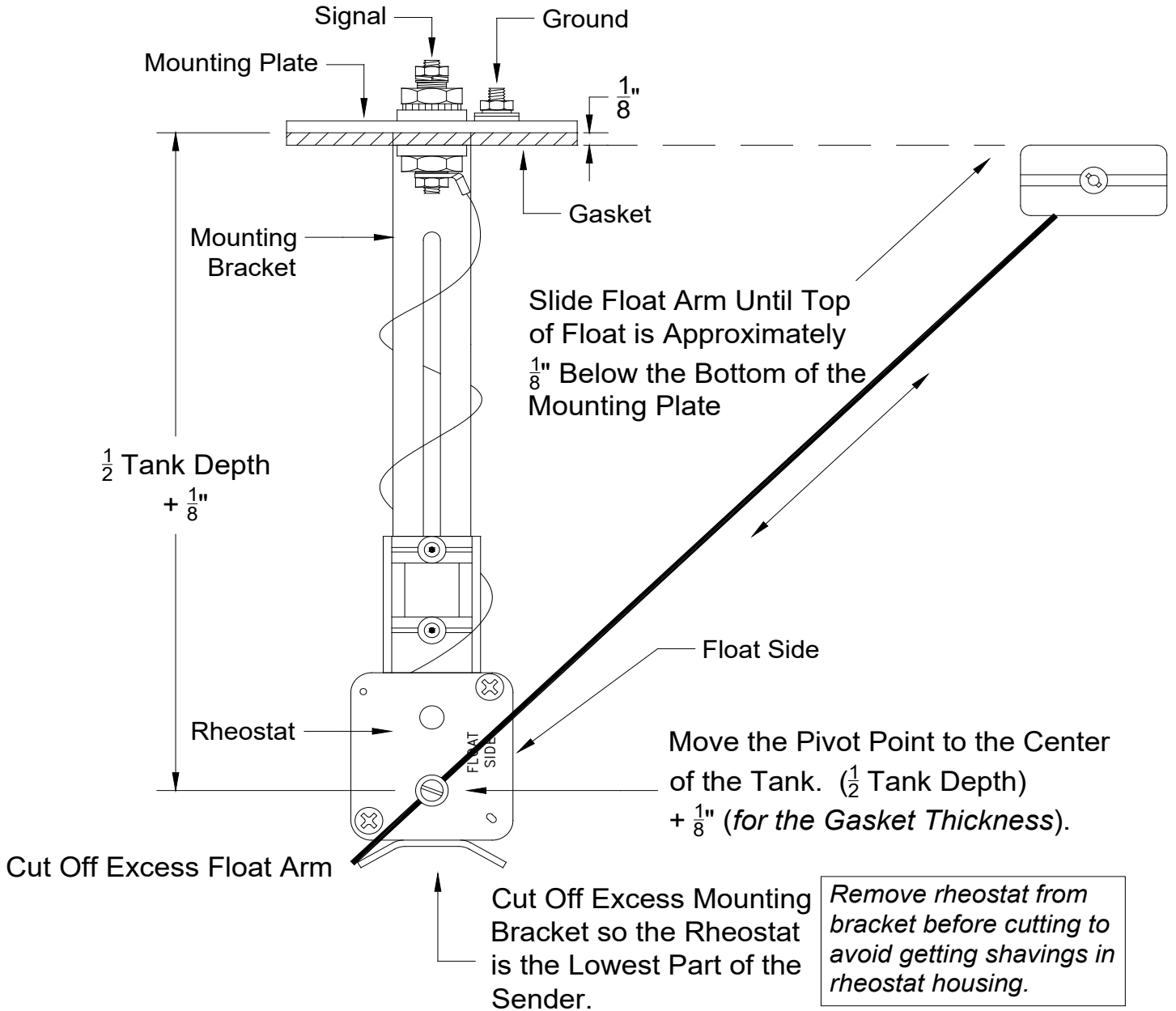

Temperature Sender Installation

(Part No. SN12mm, SN22, SN23, SN24 & SN25)

- 1) Disconnect battery before making any connections.
- 2) Install the Classic Instrument's temperature sending unit only when the engine is COLD!
- 3) DO NOT use Teflon tape on the threads. These threads are slightly tapered and designed to be self-sealing. The sender uses the threads for its ground connection and sealant may cause a poor ground causing inaccurate readings
- 4) Install the temperature sender into the proper port.
Note: Installing the sender in the engine cylinder head may cause inaccurate temperature readings.*
 - a. On GM "LS" engines, the temperature sender mounts on the passenger side of the engine under the rear cylinder. A 12mm thread sender [SN12mm] is available to fit this location.
- 5) Connect a wire from the top terminal of the temperature sender to the White wire of the temperature gauge.

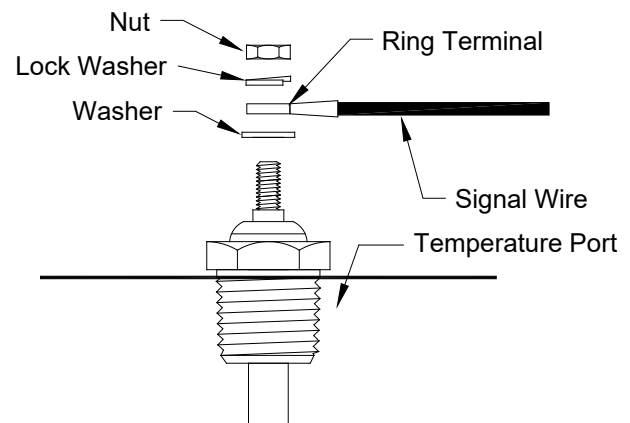

Notice: Avoid installing the temperature sender into the head of a late-model GMC engine. Even though the stock GMC sender may have been installed there, this opening is too close to the exhaust header and will most likely cause an improper reading.

Optional: VW Oil Temperature Sensor Kit [SN28A]

An available VW-type oil temperature sensor kit includes sender, metric adapter plug and VW sealing gasket. Install without modification into the oil pressure relief plug opening found on most air-cooled 1960's-type (flat-four air-cooled) VW engines. *Not for installation in the oil-drain plug opening!*

Most VW experts agree the oil pressure relief plug opening in the engine block behind the rear cylinder on the driver's side (U.S. left-hand drive) is a better choice for oil temperature sensor location than installing in the dip-stick tube or in the oil pan drain opening.

Optional: Oil Pan Temperature Sensor [SN21]

A special sender is available to monitor the temperature of the engine oil in the oil pan. This sender replaces the stock drain plug (1/2 – 20 thread) on most GM and Ford engines.

Transmission Temperature Sensor

Classic Instruments recommends monitoring the transmission fluid temperature from the transmission pan. You may need to drill and mount a weld-in bung in your pan to install the temperature sender.

In-line transmission temperature manifolds are also available for mounting the temperature sender. However, some transmission companies have stated you may get higher than normal readings if an in-line manifold is used.

Transmission fluid temperature should be kept under 210 degrees. At 230 degrees, the fluid breaks down and the clutches start to glaze resulting in transmission failure.